

T100 Instruction Manual

Content :

- I、 Product Introduction**
- II、 Application Method of PS4 Console (default firmware)**
- III、 Application Method of NS Console**
- IV、 Application Method of PC**
- V、 PC COOV Assistant**
- VI、 Firmware/Script Update**
- VII、 QuickMacro**
 - A、 Button mapping**
 - B、 Burst (off by default)**
 - C、 Auto combo**
 - D、 Auto infinite loop function (off by default)**
 - E、 Joypad vibration switch and force adjustment function**
 - F、 Four sets of independent configuration switching**
 - G、 Calibration function**
 - H、 Linear control (on by default)**

I、Product Introduction

Allowing users to connect to any popular joypad via Bluetooth on the PS4/SWITCH/PC.

Dual Bluetooth mode:

Wireless A mode and wireless B mode are not universal, and the two modes can only be used independently. After power-on T100, press and hold the T100 pairing button for 5 seconds to switch modes.



II、PS4 Console (default firmware)

The T100 default factory firmware uses a third-party controller on the PS4 Console, plug and play.

Wireless B mode: (factory default mode)

T100 Bluetooth wireless connection joypad, the indicator light is red.

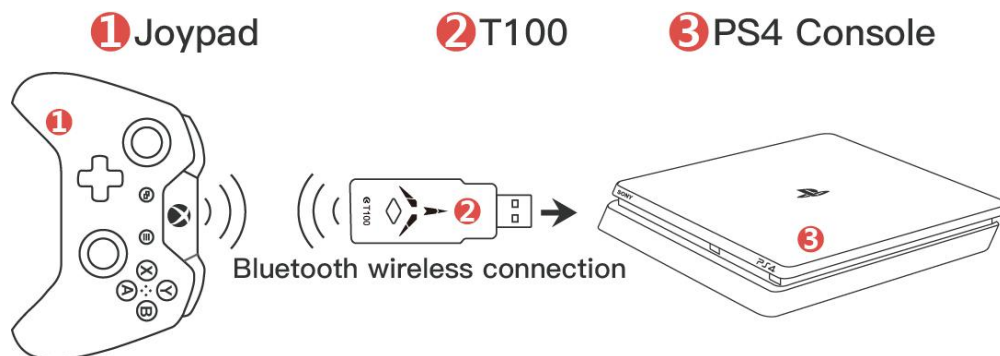

1. Disconnecting PS4 original Joypad bluetooth, the method: "Setting - Peripheral Device - Bluetooth Device - Disconnecting the Joypad"(or applying different PS4 account)
2. Insert the T100 into the PS4 Console as shown in the diagram, press the pairing button, and the indicator light flashes red (search for Bluetooth status).
3. Press the Joypad pairing button (see the Joypad pairing instructions) until the Joypad enters the search for Bluetooth status.
4. Wait for 3-5 seconds or so, the Joypad indicator light is always on, and the T100 indicator is always on. At this time, the Bluetooth pairing connection is successful. Press

the Joypad Home button, the Joypad can normally control the PS4.

Joypad pairing instructions:

PS4 Joypad Bluetooth Pairing: Press and hold the “SHARE + PS” button and the Joypad indicator will flash double. (Search for Bluetooth status)

X1 Joypad Bluetooth Pairing: Press the “X” button to start the Joypad, then press the Joypad sync button “()” button, the Joypad indicator flashes quickly. (Search for Bluetooth status)

NS Pro Joypad Bluetooth Pairing: Press and hold the “()” sync button on the top of the Joypad, and the Joypad indicator will flash in a loop. (Search for Bluetooth status)

In wireless B mode, the PS4 wake-up method:

- 1, press the PS4 host power button
2. Press the handle Home button and wait for the automatic pairing to be successful.

Wired connection:

T100 connection PS4 Console and third-party Joypad with wire, plug and play. (Only used in wireless B mode)

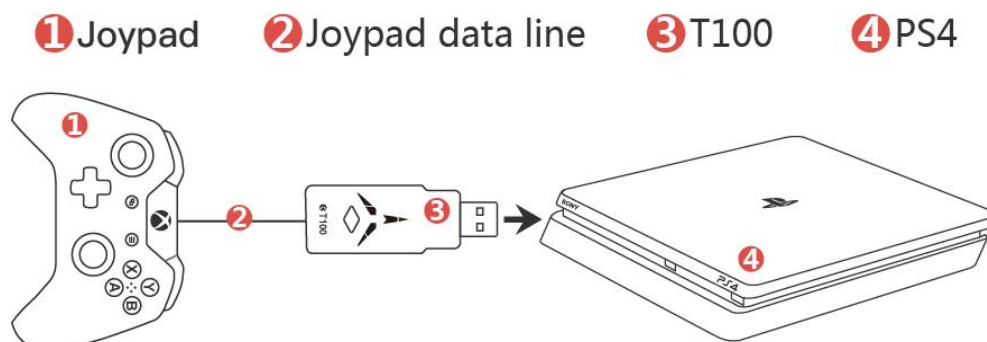

Note: When connecting the device, the last step is to access the PS4 Console.

Wireless A mode: (long press 5 seconds pairing button)

T100 connection PS4 wirelessly with Bluetooth , the indicator light is blue .

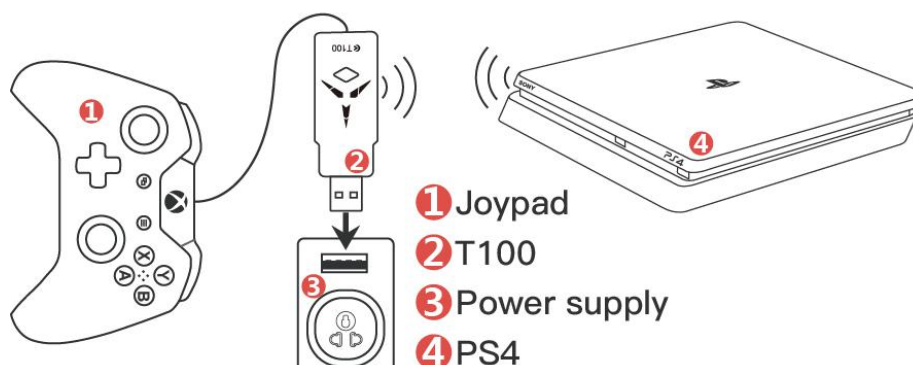

1. Disconnecting PS4 original Joypad bluetooth, the method: "Setting - Peripheral Device - Bluetooth Device - Disconnecting the Joypad"(or applying different PS4 account)
2. Connect the Joypad to the T100 via the data cable.
3. Insert the T100 into the PS4 and press and hold the pairing button for 5 seconds. At this time, the indicator light flashes blue.
4. After waiting for a few seconds, the T100 blue light is always on, the PS4 interface automatically jumps to the user selection, and the confirmation key (NS Pro **A** key / DS4 **O** key / X1 **B** key) is confirmed to be used normally.
5. Then the user can plug the T100 into the charger or power bank to control the PS4.

PS: When the user uses T100 at the second time, the T100 can be plugged into the power/power bank directly to control the PS4 (blue light status).

In wireless A mode, the wake-up method of PS4:

1. Press T100 to build and wait for the automatic pairing to be successful.

III、NS Console

The T100 factory default firmware is PS4 Console firmware. If you need T100 work on the NS Console, please go to the official website www.mycoov.com to download the COOV Assistant software to update the Switch firmware of T100.

Before use, please go to Switch -"System Settings" - "Controllers and Sensors" - "Pro Controller Wired Communication" and set to "On".





Wireless B mode:

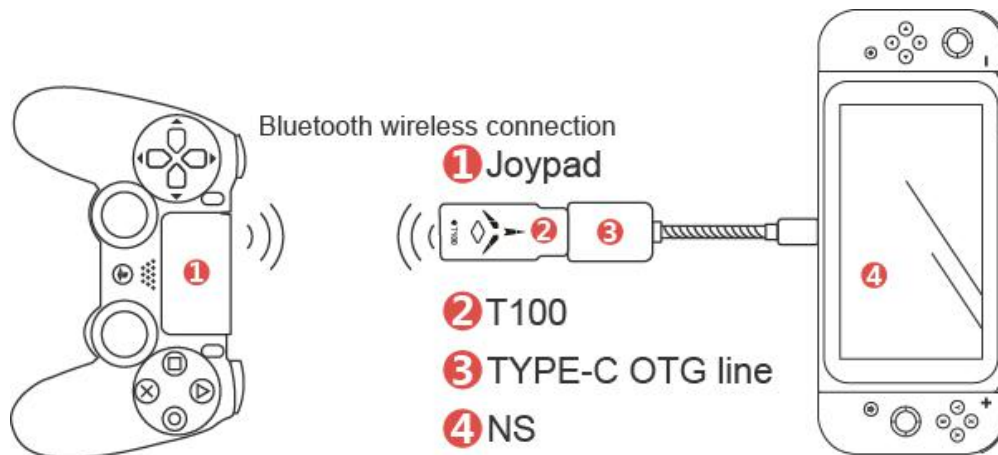

T100 connection Joypad wirelessly with Bluetooth, the indicator light is red.



1. The PS4 Joypad is in the off state.
2. Connect the T100 to the NS Console or USB port of base according to the diagram. Press the pairing button and the indicator light flashes red (Search for Bluetooth).
3. Press the Joypad pairing button (see the handle pairing instructions) until the Joypad enters the search Bluetooth state.
4. Wait 3-5 seconds or so, the Joypad indicator is always on, the T100 indicator is always on, and you can move the Joypad at random. The Joypad connection is displayed on the game display and the "USB" prompt appears. The connection is successful.

Joypad pairing instructions:

PS4 Joypad Bluetooth Pairing: Press and hold the "  +  " button and the Joypad indicator will flash double. (Search for Bluetooth status)

X1 Joypad Bluetooth Pairing: Press the "  " button to start the Joypad, then press the Joypad sync button "  " button, the Joypad indicator flashes quickly. (Search for Bluetooth status)

NS Pro Joypad Bluetooth Pairing:

1. Enter the Switch host "System Settings" - "Controllers and Sensors" - "Disconnect Controllers".



2. Press and hold the "  " sync button on the top of the Joypad, and the Joypad indicator will

flash in a loop. (Search for Bluetooth)

WS wake-up method in wireless B mode

1. Press the power button on the Switch to make the screen light up.
2. Press the Bluetooth pairing button on the N100 Plus , and waiting auto connection

Wired Connection:

T100 wired to connect NS host with third-party Joypad, plug and play. (Only used in wireless B mode)

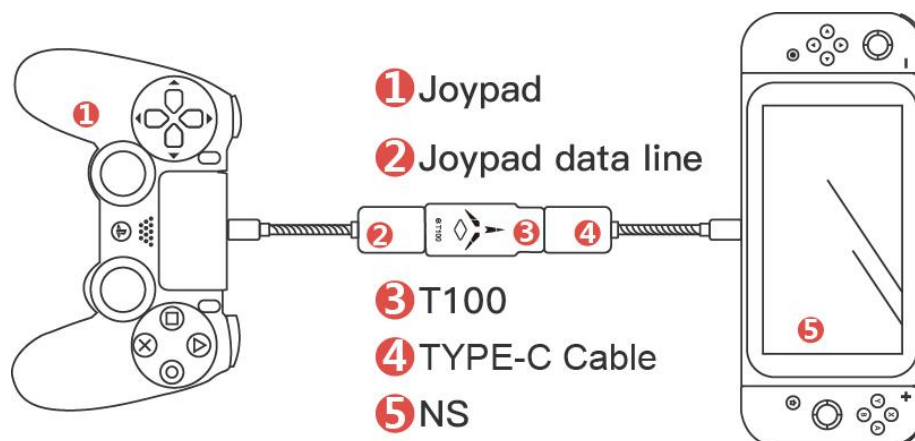

Wireless A mode: (long press 5 seconds pairing button)

T100 connect NS wirelessly with Bluetooth , the indicator light is blue light.

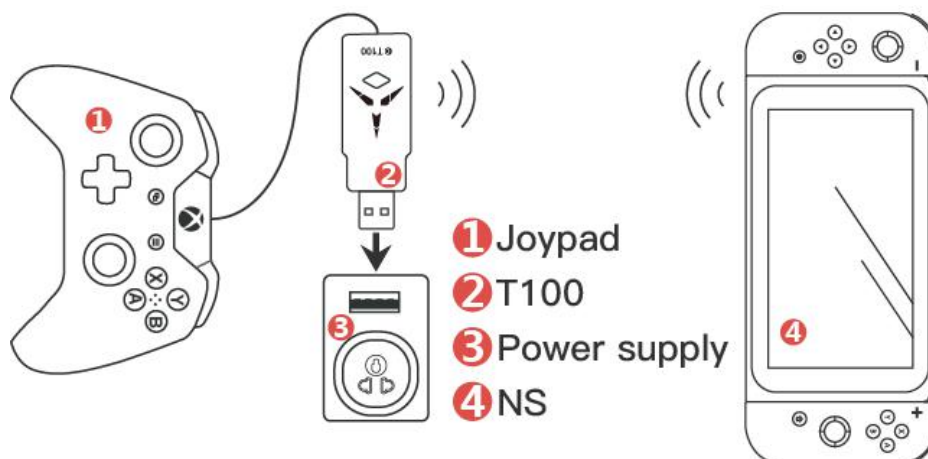

1. Go to the Switch and set the "Controllers and Sensors" - "Change Grips / Order" interface.
2. Connect the Joypad to the T100.
3. Connect the T100 to a charger or power bank (powering the T100).
4. The T100 indicator flashes Blue.
5. After the connection prompt appears on the interface, press the ENTER button (NS Pro Joypad **A** button / PS4 Joypad **○** button / X1 Joypad **B** button) to confirm the normal use.

WS wake-up method in wireless A mode

1. Press the power button on the Switch to make the screen light up.
2. Press the Bluetooth pairing button on the N100 Plus , and waiting auto connection

IV、 PC Joypad

To use the T100 on the PC , adjust the T100 to the wireless B mode (the indicator light is red) under any firmware, and then plug it into the PC USB port. The user Joypad can be connected to the xbox360 Joypad by wired or wireless connection to the T100. (Joypad Bluetooth pairing is consistent with wireless B mode)

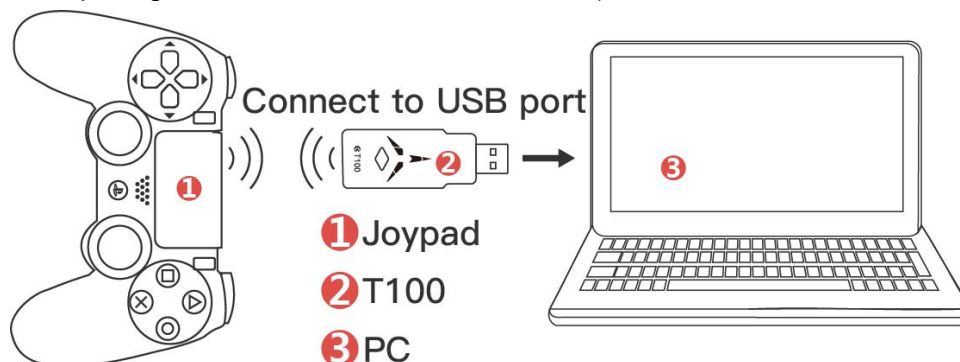

The Bluetooth connection of other Bluetooth controllers is the same as that of the DS4 controller and NS Pro controller.

V、 PC COOV Assistant

This software could provide the fast and convenient setting for COOV USB Device, including changing keys, Macro function, upgrading, recovering, sharing functions. The users could enter into the official website www.mycoov.com - the COOV Assistant download page to utilize this software. You could use it according to the relevant instructions.



VI、 Firmware/Script Update

1. Press and hold the T100 pairing button, insert the T100 into the computer's USB port, and release the pairing button, then the T100 disk will appear.
- 2, use the PC-side COOV assistant to perform online firmware script update

VII、 QuickMacro

Note 1: The same button cannot be activated with the burst function , the auto combo and Auto infinite loop function.

Note 2: During the function configuration, each effective operation triggers a handle vibration.

Note 3: The default operation is to simulate the Capture  (NS handle) by double clicking the HOME button.

A、 Button mapping

Button mapping is to map a button to another button, so as to realize the same function of several buttons or exchange functions of several buttons.



1.Setting





a. Press the PS4  button / X1  button / NS Pro  button + PS4  button / X1  button

/ NS Pro  button at the same time and release to enter the button mapping function configuration mode.



b. Press the buttons that need to be mapped

c. Press the mapping button

d. Press the PS4  button / X1  button / NS Pro  button to exit the configuration mode.

For example, press the  button first and then press the  button, so that the  button has the function of  button.



2.Single elimination



a. Press the PS4  button / X1  button / NS Pro  button + PS4  button / X1  button

/ NS Pro  button at the same time and release to enter the button mapping function configuration mode.







b. Press the button that needs to eliminate the mapping



c. Press the button that needs to eliminate the mapping again

d. Press the PS4  button / X1  button / NS Pro  button to exit the configuration mode.





For example, press the  button first, and then press the  button once again, so that the  button will restore the default function.

3. Elimination







a. Press the PS4  button / X1  button / NS Pro  button + PS4  button / X1  button / NS Pro  button at the same time and release to enter the button mapping function configuration mode.

b. Hold down the PS4  button / X1  button / NS Pro  button for 3 seconds, all the configured button mappings will be eliminated automatically, and it will exit the configuration mode automatically.

4. Examples 1



a. First map the  button to , and then map the  button to , so that the two buttons can exchange function.













(In the button mapping mode, the operation is to press , , , )

b. Map the  button to , map  to , and then map  to , so that the three buttons can exchange function; and so forth

(In the button mapping mode, the operation is to press , , , , , )

5. Examples 2(exchange touchpad and SHARE)

a. In this configuration process, double-click PS4  button / X1  button / NS Pro  button can not be simulated into other keys, so you need ps4 handle or pro handle for this operation

b. Enter key mapping function configuration mode, press the (PS4  button / X1  button / NS Pro  button) / (PS4  button / NS Pro  button) / (PS4  button / NS Pro  button) / (PS4  button / X1  button / NS Pro  button), then press PS4  button / X1  button / NS Pro  button to exit



6. Button supported

All buttons except the PS4  button / X1  button / NS Pro  button and the rocker



B. Burst (off by default)

Burst control is used to configure the selected button to a burst mode. When the button is in a burst mode, once it is pressed, it will simulate the pressing-releasing event at a certain frequency, and the frequency is adjustable.

1. Turn on the burst





a. Press the PS4  button / X1  button / NS Pro  button + PS4  button / X1  button

/ NS Pro  button at the same time and release to enter the burst function configuration mode.



b. Hold down the button that needs to turn on the burst function, and then press the PS4  button / X1  button / NS Pro  button, so that the burst function of the corresponding button can be turned on.

c. Press the PS4  button / X1  button / NS Pro  button to exit the configuration mode.

2. Turn on the burst

a. Press the PS4  button / X1  button / NS Pro  button + PS4  button / X1  button

/ NS Pro  button at the same time and release to enter the burst function configuration mode.



b. Hold down the button that needs to turn off the burst function, and then press the PS4  button / X1  button / NS Pro  button, so that the burst function of the corresponding button can be turned off.

c. Press the PS4  button / X1  button / NS Pro  button to exit the configuration mode.

3. Elimination of all the burst











a. Press the PS4  button / X1  button / NS Pro  button + PS4  button / X1  button

/ NS Pro  button at the same time and release to enter the burst function configuration mode.

b. Hold down the PS4  button / X1  button / NS Pro  button for 3 seconds, all the configured burst function will be eliminated automatically, and it will exit the configuration

























mode automatically.

4. Adjust the burst frequency (Basic mode)

- a. Press the PS4  button / X1  button / NS Pro  button + PS4  button / X1  button / NS Pro  button at the same time and release to enter the burst function configuration mode.
- b. Press the  to increase the burst frequency
- c. Press the  to reduce the burst frequency
- d. Press the PS4  button / X1  button / NS Pro  button to exit the configuration mode.

5. Adjust the burst frequency (Custom mode)

In custom mode, the user can set two parameters: press time a millisecond and release time b milliseconds. When the burst starts, the key is automatically pressed for a millisecond, then released for b milliseconds, and then pressed a millisecond for a round trip. The values of a and b should be greater than 4 and less than 252.



- a. Determine the value you want to set, such as a is 128, b is 164
- b. Press the PS4  button / X1  button / NS Pro  button + PS4  button / X1  button / NS Pro  button at the same time left and release, enter the serial configuration mode
- c. Hold down the middle PS4  button / X1  button / NS Pro  button and PS4  button / X1  button / NS Pro  button, and do not release
- d. set a value: press the , the value of a increase of 100; press the right two , a value increased by 20; press the eight , a value increased by 8. Total 128
- e. Set the b value: Press the , the value of b increases by 100; press the six , the b value increases by 60; press the four , the b value increases by 4. Total 164
- f. release the middle and PS4  button / X1  button / NS Pro  button and PS4  button / X1  button / NS Pro  button, the normal configuration, it will flash

green light.

g. If there is a configuration error during step 2 through step 6, you can reconfigure from step 2. A value and b value can also be set separately.

h. Press the PS4  button / X1  button / NS Pro  button to exit the configuration mode

5.Button supported

All the buttons except PS4  button / X1  button / NS Pro  button, the

PS4  button / X1  button / NS Pro  button and the PS4  button / X1  button

/ NS Pro  button and the rocker

C、 Auto combo



In the fighting games, an ultimate skill often needs to operate the handle in a certain rule. The auto combo can record the combo and set to trigger by a certain button. After the setting, the player can use the auto combo.



1.Setting

a. Press the PS4  button / X1  button / NS Pro  button + PS4  button / X1  button

/ NS Pro  button at the same time and release to enter the auto combo function configuration mode.

b. Carry out the auto combo operation, and the device will record the combo automatically (it can record 8 groups of combo at most, 5 seconds of each combo at least, and the operation will not be shielded)



c. Press the PS4  button / X1  button / NS Pro  button



d. Press the button used to trigger the combo. After setting up successfully, it will exit the configuration mode automatically (or press the PS4  button / X1  button / NS Pro  button once more to exit).

2.Single elimination







a. Press the PS4  button / X1  button / NS Pro  button + PS4  button / X1  button



/ NS Pro  button at the same time and release to enter the auto combo function configuration mode.

b. Press the PS4  button / X1  button / NS Pro  button







c. Press the configured trigger button. After setting up successfully, it will exit the configuration mode automatically (or press the PS4  button / X1  button / NS Pro  button once more to exit).

3. Whole elimination

a. Press the PS4  button / X1  button / NS Pro  button + PS4  button / X1  button / NS Pro  button at the same time and release to enter the auto combo function configuration mode.

b. Hold down the PS4  button / X1  button / NS Pro  button for 3 seconds, all the configured auto combos will be eliminated automatically, and it will exit the configuration mode automatically.

4. Button support

All buttons except the PS4  button / X1  button / NS Pro  button and the rocker can be used for triggering. All buttons except the PS4  button / X1  button / NS Pro  button can be used for recording.





D. Auto infinite loop function (off by default)

This function can perform infinite loop functions on selected buttons. When the button is pressed, the button is locked in the held down state until the button is pressed again and released. This function can achieve an infinite automatic operation of one button.

Note: When using the infinite loop function, if you want to perform other function configuration, you need to stop the infinite loop state.



1. Turn on the infinite loop function of the button

(Please do not enter configuration mode in the loop state)

a. Press the PS4  button / X1  button / NS Pro  button +  at the same time and release to enter the infinite loop function configuration mode.











b. Perform the operation that needs to be cycled, and the device will automatically record the operation. (it can record 8 groups of combo at most, 5 seconds of each combo at least, and the operation will not be shielded)

c. Press the PS4  button / X1  button / NS Pro  button

d. Press the button that triggers this infinite loop. After the setting is successful, the configuration mode will be automatically exited. (or press the PS4  button / X1  button / NS Pro  button once more to exit)







2. Clear a single Auto infinite loop function

(Please do not enter the configuration mode in the loop state, for example, the A key is in the infinite loop state, please press the A key again to exit this state)

- a. Press the PS4  button / X1  button / NS Pro  button +  at the same time and release to enter the infinite loop function configuration mode.
- b. Press the PS4  button / X1  button / NS Pro  button
- c. Click the button that previously configured to trigger an infinite loop. After setting up successfully, it will exit the configuration mode automatically (or press the PS4  button / X1  button / NS Pro  button once more to exit).

3. Clear all Auto infinite loop functions









(Please do not enter the configuration mode in the loop state, for example, the A key is in the infinite loop state, please press the A key again to exit this state)

- a. Press the PS4  button / X1  button / NS Pro  button +  at the same time and release to enter the infinite loop function configuration mode.
- b. Hold down the PS4  button / X1  button / NS Pro  button for 3 seconds, all the configured infinite loop function will be eliminated automatically, and it will exit the configuration mode automatically.











4. Start/stop infinite loop

- a. Press the button that has set the infinite loop function to enter the infinite loop state.
- b. Press this button again to exit the infinite loop state

5. Button supported

All the buttons except PS4  button / X1  button / NS Pro  button, PS4  button / X1  button / NS Pro  button, PS4  button / X1  button / NS Pro  button and the rocker.

E、 Joypad vibration switch and force adjustment function

- a. Simultaneously press PS4  button / X1  button / NS Pro  button + PS4  button / X1  button / NS Pro  button and release to enter vibration configuration mode
- b. Click the  s to improve the vibration intensity
- c. Click the , reduce the vibration intensity (to a minimum, turn off the vibration)
- d. Press the PS4  button / X1  button / NS Pro  button to exit the configuration mode

DS3 handle can not adjust the vibration intensity, only the switch function

F、 Four sets of independent configuration switching

The V5.0 firmware can save 4 sets of configurations at the same time, and the first set of configurations is loaded by default when booting. The configurations between the groups

do not interfere with each other and can be quickly switched using PS4  button /

X1  button / NS Pro  button + PS4  button / X1  button / NS Pro  button

or PS4  button / X1  button / NS Pro  button + PS4  button / X1  button /

NS Pro  button. LEDs (red, green, blue, yellow) and vibration prompts when switching.

Use scenarios such as:

- a. the first set of configuration features default, only use the handle conversion function.
- b. the second group for the jet fighter 2, opened the burst function, open a one-button big move function.
- c. the third group for the blade of the different degrees 2, open one-click continuous strokes and button locks, used to brush reputation, etc.
- d. other games

G、 Calibration function

The calibration function can solve the problem of rocker drift on part of the handles without increasing the dead zone.



1. Calibration:

a. Press the PS4  button / X1  button / NS Pro  button + PS4  button /

X1  button / NS Pro  button at the same time and release to enter the calibration







configuration mode.



b. Try to turn the two rockers until the handle stops vibration

c. After the vibration is stopped, release the two rockers and press the PS4  button / X1  button / NS Pro  button.

d. Wait for 1 second, and it will exit the calibration mode automatically.

2. Elimination of calibration information:

a. Press the PS4  button / X1  button / NS Pro  button + PS4  button / X1  button / NS Pro  button at the same time and release to enter the calibration configuration mode.

b. Hold down the PS4  button / X1  button / NS Pro  button for 3 seconds, all the calibration parameters will be eliminated automatically, and it will exit the configuration mode automatically.







Recommendation for use:



Most of the original handle does not need to be calibrated. If the rocker drifts, it is suggested to calibrate first.

H、 Linear control (on by default)

Linear control is used to turn off or turn on the linear response of the handle rocker and trigger to achieve a shorter bond range and faster response speed.







1. Turn off the linear

a. Press the PS4  button / X1  button / NS Pro  button + PS4  button / X1  button / NS Pro  button at the same time and release to enter the linear control function configuration mode.



b. Press the trigger that need to turn off the linear function, or dial the rocker that need to turn off the linear function, and then click the PS4  button / X1  button / NS Pro  button to turn off the linear function of the corresponding trigger or rocker.

c. Press the PS4  button / X1  button / NS Pro  button to exit the configuration mode.



2. Turn off the linear

a. Press the PS4  button / X1  button / NS Pro  button + PS4  button / X1  button / NS Pro  button at the same time and release to enter the linear control function

configuration mode.

b. B. Press the trigger that need to turn on the linear function, or dial the rocker that need to turn on the linear function, and then click the PS4  button / X1  button / NS



Pro  button to turn on the linear function of the corresponding trigger or rocker.

c. Press the PS4  button / X1  button / NS Pro  button to exit the configuration mode.

3. Turn on the linear of all buttons

a. Press the PS4  button / X1  button / NS Pro  button + PS4  button / X1  button

/ NS Pro  button at the same time and release to enter the linear control function configuration mode.

b. Hold down the PS4  button / X1  button / NS Pro  button for 3 seconds, then all the linear functions will be turned on automatically, and it will exit the configuration mode automatically.

4. Button supported

Two rockers and two triggers